

Acer LCD Monitor

User's Guide

Copyright © 2016. Acer Incorporated.
All Rights Reserved.

Acer LCD Monitor User's Guide
Original Issue: 12/2016

Changes may be made periodically to the information in this publication without obligation to notify any person of such revisions or changes. Such changes will be incorporated in new editions of this manual or supplementary documents and publications. This company makes no representations or warranties, either expressed or implied, with respect to the contents hereof and specifically disclaims the implied warranties of merchantability or fitness for a particular purpose.

Record the model number, serial number, purchase date and place of purchase information in the space provided below. The serial number and model number are recorded on the label affixed to your computer. All correspondence concerning your unit should include the serial number, model number and purchase information.

No part of this publication may be reproduced, stored in a retrieval system, or transmitted, in any form or by any means, electronically, mechanically, by photocopy, recording or otherwise, without the prior written permission of Acer Incorporated.

Acer LCD Monitor User's Guide

Model number: _____

Serial number: _____

Date of purchase: _____

Place of purchase: _____

Acer and the Acer logo are registered trademarks of Acer Incorporated. Other companies' product names or trademarks are used herein for identification purposes only and belong to their respective companies.

Special notes on LCD monitors

The following are normal with the LCD monitor and do not indicate a problem.

- Due to the nature of the fluorescent light, the screen may flicker during initial use. Turn off the power switch and then turn it on again to make sure the flicker disappears.
- You may find slightly uneven brightness on the screen depending on the desktop pattern you use.
- The LCD screen has 99.99% or more effective pixels. It may include blemishes of 0.01% or less such as a missing pixel or a pixel lit all the time.
- Due to the nature of the LCD screen, an afterimage of the previous screen may remain after switching the image, when the same image is displayed for hours. In this case, the screen is recovered slowly by changing the image or turning off the power switch for a few hours.
- Acer monitor is purposed for video and visual display of information obtained from electronic devices.

Information for your safety and comfort

Safety instructions

Read these instructions carefully. Keep this document for future reference. Follow all warnings and instructions marked on the product.

Cleaning your monitor

Please carefully follow these guidelines when cleaning the monitor:

- Always unplug the monitor before cleaning.
- Use a soft cloth to wipe the screen and cabinet front and sides.

Connecting/disconnecting the device

Observe the following guidelines when connecting and disconnecting power from the LCD monitor:

- Make sure the monitor is attached to its base before connecting the power cord to the AC power outlet.
- Make sure both the LCD monitor and the computer are turned off before connecting any cable or unplugging the power cord.
- If the system has multiple sources of power, disconnect power from the system by unplugging all power cords from the power supplies.

Accessibility

Be sure that the power outlet you plug the power cord into is easily accessible and located as close to the equipment operator as possible. When you need to disconnect power from the equipment, be sure to unplug the power cord from the electrical outlet.

Safe listening

To protect your hearing, follow these instructions.

- Gradually increase the volume until you can hear it clearly and comfortably and without distortion.
- After setting the volume level, do not increase it after your ears have adjusted.
- Limit the amount of time listening to music at high volume.
- Avoid turning up the volume to block out noisy surroundings.
- Turn the volume down if you can't hear people speaking near you.

Warnings

- Do not use this product near water.
- Do not place this product on an unstable cart, stand or table. If the product falls, it could be seriously damaged.
- Slots and openings are provided for ventilation to ensure reliable operation of the product and to protect it from overheating. These openings must not be blocked or covered. The openings should never be blocked by placing the product on a bed, sofa, rug or other similar surface. This product should never be placed near or over a radiator or heat register, or in a built-in installation unless proper ventilation is provided.
- Never push objects of any kind into this product through cabinet slots as they may touch dangerous voltage points or short-out parts that could result in a fire or electric shock. Never spill liquid of any kind onto or into the product.
- To avoid damage of internal components and to prevent battery leakage, do not place the product on a vibrating surface.
- Never use it under sporting, exercising, or any vibrating environment which will probably cause unexpected short current or damage internal devices.

Using electrical power

- This product should be operated from the type of power indicated on the marking label. If you are not sure of the type of power available, consult your dealer or local power company.
- Do not allow anything to rest on the power cord. Do not locate this product where people will walk on the cord.
- If an extension cord is used with this product, make sure that the total

ampere rating of the equipment plugged into the extension cord does not exceed the extension cord ampere rating. Also, make sure that the total rating of all products plugged into the wall outlet does not exceed the fuse rating.

- Do not overload a power outlet, strip or receptacle by plugging in too many devices. The overall system load must not exceed 80% of the branch circuit rating. If power strips are used, the load should not exceed 80% of the power strip's input rating.
- This product's power cord is equipped with a three-wire grounded plug. The plug only fits in a grounded power outlet. Make sure the power outlet is properly grounded before inserting the power cord plug. Do not insert the plug into a non-grounded power outlet. Contact your electrician for details.



.....

Warning! The grounding pin is a safety feature. Using a power outlet that is not properly grounded may result in electric shock and/or injury.



.....

Note: The grounding pin also provides good protection from unexpected noise produced by other nearby electrical devices that may interfere with the performance of this product.

- Use the product only with the supplied power supply cord set. If you need to replace the power cord set, make sure that the new power cord meets the following requirements: detachable type, UL listed/CSA certified, type SPT-2, rated 7 A 125 V minimum, VDE approved or its equivalent, 4.5 meters (15 feet) maximum length.

Product servicing

Do not attempt to service this product yourself, as opening or removing covers may expose you to dangerous voltage points or other risks. Refer all servicing to qualified service personnel.

Unplug this product from the wall outlet and refer servicing to qualified service personnel when:

- the power cord or plug is damaged, cut or frayed
- liquid was spilled into the product
- the product was exposed to rain or water
- the product has been dropped or the case has been damaged
- the product exhibits a distinct change in performance, indicating a need for service
- the product does not operate normally after following the operating instructions



.....

Note: Adjust only those controls that are covered by the operating instructions, since improper adjustment of other controls may result in damage and will often require extensive work by a qualified technician to restore the product to normal condition.

Potentially explosive environments

Switch off your device in any area with a potentially explosive atmosphere and obey all signs and instructions. Potentially explosive atmospheres include areas where you would normally be advised to turn off your vehicle engine. Sparks in such areas could cause an explosion or fire resulting in bodily injury or even death. Switch off the device near gas pumps at service stations. Observe restrictions on the use of radio equipment in fuel depots, storage and distribution areas; chemical plants; or where blasting operations are in progress. Areas with a potentially explosive atmosphere are often, but not always, marked. They include below deck on boats, chemical transfer or storage facilities, vehicles using liquefied petroleum gas (such as propane or butane), and areas where the air contains chemicals or particles such as grain, dust or metal powders.

Additional safety information

Your device and its enhancements may contain small parts. Keep them out of the reach of small children.

IT Equipment Recycling Information

Acer is strongly committed to environmental protection and views recycling, in the form of salvaging and disposal of used equipment, as one of the company's top priorities in minimizing the burden placed on the environment.

We at Acer are very conscious of the environmental effects of our business and strive to identify and provide the best working procedures to reduce the environmental impact of our products.

For more information and help when recycling, please go to this website:
<http://www.acer-group.com/public/Sustainability/>

Visit www.acer-group.com for further information on the features and benefits of our other products.

Disposal instructions

Do not throw this electronic device into the trash when discarding. To minimize pollution and ensure utmost protection of the global environment, please recycle. For more information on the Waste from Electrical and Electronics Equipment (WEEE) regulations, visit <http://www.acer-group.com/public/Sustainability>



LCD pixel statement

The LCD unit is produced with high-precision manufacturing techniques. Nevertheless, some pixels may occasionally misfire or appear as black or red dots. This has no effect on the recorded image and does not constitute a malfunction.

This product has been shipped enabled for power management:

- Activate display's Sleep mode within 15 minutes of user inactivity.
- Activate computer's Sleep mode within 30 minutes of user inactivity.
- Wake the computer from Sleep mode by pushing the power button.

Tips and information for comfortable use

Computer users may complain of eyestrain and headaches after prolonged use. Users are also at risk of physical injury after long hours of working in front of a computer. Long work periods, bad posture, poor work habits, stress, inadequate working conditions, personal health and other factors greatly increase the risk of physical injury.

Incorrect computer usage may lead to carpal tunnel syndrome, tendonitis, tenosynovitis or other musculoskeletal disorders. The following symptoms may appear in the hands, wrists, arms, shoulders, neck or back:

- numbness, or a burning or tingling sensation
- aching, soreness or tenderness
- pain, swelling or throbbing
- stiffness or tightness
- coldness or weakness

If you have these symptoms, or any other recurring or persistent discomfort and/or pain related to computer use, consult a physician immediately and inform your company's health and safety department.

The following section provides tips for more comfortable computer use.

Finding your comfort zone

Find your comfort zone by adjusting the viewing angle of the monitor, using a footrest, or raising your sitting height to achieve maximum comfort. Observe the following tips:

- refrain from staying too long in one fixed posture
- avoid slouching forward and/or leaning backward
- stand up and walk around regularly to remove the strain on your leg muscles

Taking care of your vision

Long viewing hours, wearing incorrect glasses or contact lenses, glare, excessive room lighting, poorly focused screens, very small typefaces and low-contrast displays could stress your eyes. The following sections provide suggestions on how to reduce eyestrain.

Eyes

- Rest your eyes frequently.
- Give your eyes regular breaks by looking away from the monitor and focusing on a distant point.
- Blink frequently to keep your eyes from drying out.

Display

- Keep your display clean.
- Keep your head at a higher level than the top edge of the display so your eyes point downward when looking at the middle of the display.
- Adjust the display brightness and/or contrast to a comfortable level for enhanced text readability and graphics clarity.
- Eliminate glare and reflections by:
 - placing your display in such a way that the side faces the window or any light source
 - minimizing room light by using drapes, shades or blinds
 - using a task light
 - changing the display's viewing angle
 - using a glare-reduction filter
 - using a display visor, such as a piece of cardboard extended from the display's top front edge
- Avoid adjusting your display to an awkward viewing angle.
- Avoid looking at bright light sources, such as open windows, for extended periods of time.

Developing good work habits

Develop the following work habits to make your computer use more relaxing and productive:

- Take short breaks regularly and often.
- Perform some stretching exercises.
- Breathe fresh air as often as possible.
- Exercise regularly and maintain a healthy body.

TABLE OF CONTENTS

UNPACKING.....	1
ATTACHING / REMOVING THE BASE.....	2
SCREEN POSITION ADJUSTMENT	3
CONNECTING THE POWER CORD.....	4
SAFETY PRECAUTION.....	4
CLEANING YOUR MONITOR.....	4
POWER SAVING.....	5
DDC.....	5
CONNECTOR PIN ASSIGNMENT.....	6
Standard Timing Table	8
INSTALLATION.....	9
USER CONTROLS	10
TROUBLESHOOTING	19

UNPACKING

Please check the following items are present when you unpack the box, and save the packing materials in case you will need to ship or transport the monitor in future.

- LCD Monitor
- Quick Start Guide
- AC Power Cord

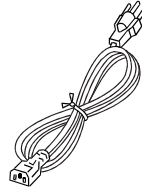
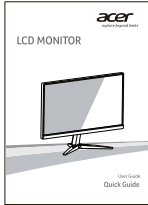
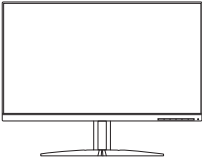

- HDMI Cable (Optional)
- VGA Cable (Optional)
- DP Cable (Optional)

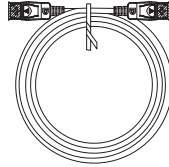
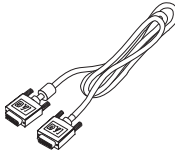
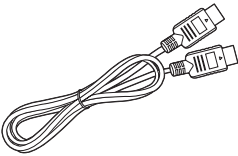

- Audio Cable (Optional)
- DVI Cable (Optional)

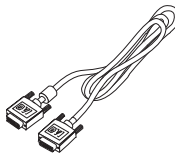
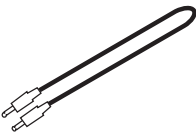

ATTACHING / REMOVING THE BASE



Note: Remove the monitor and monitor base from its packaging. Carefully place the monitor face-down on a stable surface -- use a cloth to avoid scratching the screen.

1. Attach the stand arm and the base to the monitor, as illustrated.

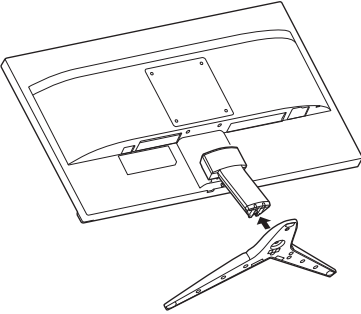

2. Ensure that the base is screwed tight onto the monitor stand arm.

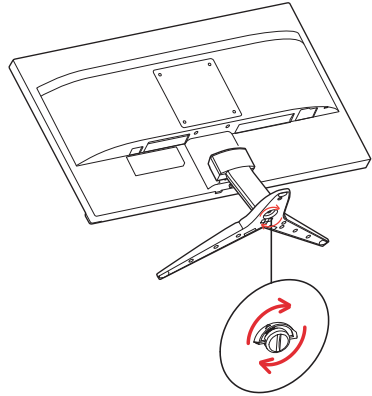

Note: If installing with a wall mounting kit, it is recommended to use M4 x 10 (L) mm screws to fix your monitor on the wall.

SCREEN POSITION ADJUSTMENT

In order to optimize the best viewing position, you can adjust the tilt of the monitor.

- **Tilt**

Please see the illustration below for an example of the tilt range.

The monitor can be adjusted to 15 degrees up or 5 degrees down as indicated by arrow below.

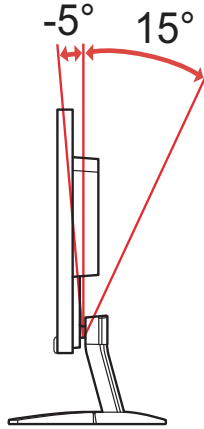

CONNECTING THE POWER CORD

- Check first to make sure that the power cord you use is the correct type required for your area.
- This monitor has a universal power supply that allows operation in either 100/120V AC or 220/240 V AC voltage area. No user-adjustment is required.
- Plug one end of the power cord to the AC inlet, and plug the other end into an AC outlet.
- For unit using at 120 V AC:
Use a UL Listed Cord Set, Type SVT wire and plug rated 10 A/125 V.
- For unit using at 220/240 V AC (outside of U.S.):
Use a Cord Set consisting of H05VV-F cord and plug rated 10 A, 250 V. The cord set should have the appropriate safety approvals for the country in which the equipment will be installed.

SAFETY PRECAUTION

- Avoid placing the monitor, or any other heavy object, on the power cord to avoid damage to the cable.
- Do not expose the monitor to rain, excessive moisture, or dust.
- Do not cover the ventilation slots or openings of the monitor. Always put the monitor in a place where there is adequate ventilation.
- Avoid placing the monitor against a bright background or where sun-light or other light sources may reflect on the face of the monitor. Place the monitor just below eye level.
- Handle with care when transporting the monitor.
- Refrain from giving shock or scratch to the screen, as screen is fragile.
- In order to prevent damage to the monitor, do not lift the monitor by its base.

CLEANING YOUR MONITOR

Please carefully follow the below guidelines when cleaning the monitor.

- Always unplug the monitor before cleaning.
- Use a soft cloth to gently wipe the screen and cabinet front and sides.
- **NEVER SPRAY OR POUR ANY LIQUID DIRECTLY ONTO THE SCREEN OR CASE.**
- **PLEASE DO NOT USE ANY AMMONIA OR ALCOHOL-BASED CLEANERS ON THE LCD DISPLAY SCREEN OR CASE.**
- Acer will not be liable for damage resulting from use of any ammonia or alcohol-based cleaners.

POWER SAVING

The monitor will be driven into “Power Saving” mode by the control signal from the display controller, as indicated by the amber-color power LED.

State	LED Light
ON	Blue
Power Saving Mode	Amber

The power saving states will be kept until a control signal has been detected or the keyboard or mouse is activated. The recovery time from Active OFF state back to ON state is around 3 seconds.

DDC

To make your installation easier, the monitor is able to Plug and Play with your system if your system also supports DDC protocol. The DDC (Display Data Channel) is a communication protocol through which the monitor automatically informs the host system about its capabilities, for example, supported resolutions and corresponding timing. The monitor supports DDC2B standard.

CONNECTOR PIN ASSIGNMENT

19-Pin Color Display Signal Cable

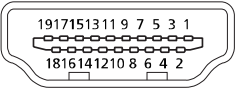

PIN	Meaning	PIN	Meaning
1.	TMDS Data2+	10.	TMDS Clock+
2.	TMDS Data2 Shield	11.	TMDS Clock Shield
3.	TMDS Data2-	12.	TMDS Clock-
4.	TMDS Data1+	13.	CEC
5.	TMDS Data1 Shield	14.	Reserved (N.C. on device)
6.	TMDS Data1-	15.	SCL
7.	TMDS Data0+	16.	SDA
8.	TMDS Data0 Shield	17.	DDC/CEC Ground
9.	TMDS Data0-	18.	+5V Power
		19.	Hot Plug Detect

20-Pin Color Display Signal Cable

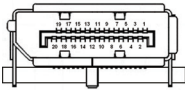

PIN	Description	PIN	Description
1.	Lane0(p)	11.	GND
2.	GND	12.	Lane3(n)
3.	Lane0(n)	13.	Config1
4.	Lane1(p)	14.	Config2
5.	GND	15.	AUX_CH (n)
6.	Lane1(n)	16.	GND
7.	Lane2(p)	17.	AUX_CH (p)
8.	GND	18.	Hot Plug Detect
9.	Lane3(n)	19.	DP Power_Return
10.	Lane3(p)	20.	DP Power

15-Pin Color Display Signal Cable

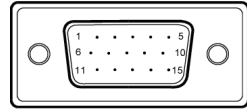

PIN NO.	DESCRIPTION	PIN NO.	DESCRIPTION
1.	Red	9.	+5V
2.	Green	10.	Logic Ground
3.	Blue	11.	Monitor Ground
4.	Monitor Ground	12.	DDC-Serial Data
5.	DDC-return	13.	H-Sync
6.	R-Ground	14.	V-Sync
7.	G-Ground	15.	DDC-Serial Clock
8.	B-Ground		

24-Pin Color Display Signal Cable

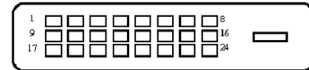

PIN	Meaning	PIN	Meaning
1.	TMDS Data2-	13.	NC
2.	TMDS Data2+	14.	+5V Power
3.	TMDS Data 2/4 Shield	15.	Logic Ground
4.	NC	16.	Hot Plug Detect
5.	NC	17.	TMDS Data0-
6.	DDC Clock	18.	TMDS Data0+
7.	DDC Data	19.	TMDS Data 0/5 Shield
8.	NC	20.	NC
9.	TMDS Data1-	21.	NC
10.	TMDS Data1+	22.	TMDS Clock Shield
11.	TMDS Data 1/3 Shield	23.	TMDS Clock+
12.	NC	24.	DDC TMDS Clock-

Standard Timing Table

	Mode	Resolution		
1	VGA	640 x 480	60	Hz
2	MAC	640 x 480	66.66	Hz
3	VESA	720 x 400	70	Hz
4	SVGA	800 x 600	56	Hz
5	SVGA	800 x 600	60	Hz
6	XGA	1024 x 768	60	Hz
7	XGA	1024 x 768	70	Hz
8	VESA	1152 x 864	75	Hz
9	SXGA	1280 x 1024	60	Hz
10	VESA	1280 x 720	60	Hz
11	WXGA	1280 x 800	60	Hz
12	WXGA+	1440 x 900	60	Hz
13	WSXGA+	1680 x 1050	60	Hz
14	UXGA	1920 x 1080	60	Hz
15*	UXGA	1920 x 1080	75	Hz
16*	UXGA	1920 x 1080	120	Hz
17**	UXGA	1920 x 1080	144	Hz

* For Dual-Link DVI/DisplayPort/HDMI only.

** For DisplayPort/HDMI only.



Note: DisplayPort/HDMI are purposely supporting the AMD FreeSync technology and target AMD graphic solutions. For other GPUs, please contact the graphic card manufactures whether they can support or not.

INSTALLATION

To install the monitor to your host system, please follow the steps as given below:

Steps



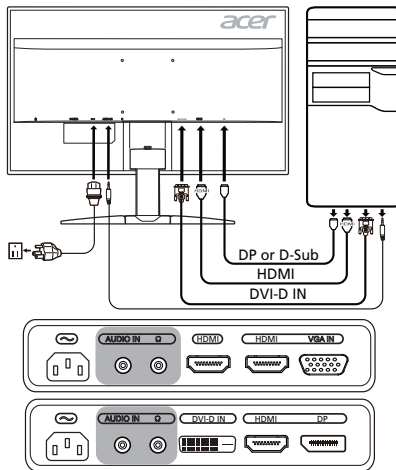



1. 1-1 Connect Video Cable (Only D-Sub-input Model)
 - a. Make sure both the monitor and computer are powered-OFF.
 - b. Connect the VGA video cable to the computer.
- 1-2 Connect HDMI Cable
 - a. Make sure both the monitor and computer are powered-OFF.
 - b. Connect the HDMI cable to the computer.
- 1-3 Connect DP Cable (Only DP-input Model)
 - a. Make sure both the monitor and computer are powered-OFF.
 - b. Connect the DP cable to the computer.
- 1-4 Connect Digital Cable (Only Dual-input model)
 - a. Make sure both the monitor and computer are powered-OFF.
 - b. Connect one end of the 24-pin DVI cable to the back of the monitor and connect the other end to the computer's port.
2. Connect the Audio Cable (Optional)
3. Insert the monitor power cable into the power port at the back of the monitor.
4. Plug the power cords of your computer and your monitor into a nearby electrical outlet.



■ Optional

USER CONTROLS

Base Controls

Icon	Item	Description
	Power button/ indicator	Turns the monitor on/off. Blue indicates power on. Amber indicates standby/power saving mode.
	OSD functions	Press to view the OSD. Press again to enter a selection in the OSD.
	Input button	Press to toggle input sources.
	Volume button	Press to activate the volume sliding scale.
	Brightness	Press the key to open the Brightness control and set it to your preferred level.
	Mode	Press to trigger Mode control.

Adjusting the OSD settings



Note: The following content is for general reference only. Actual product specifications may vary.

The OSD (on-screen display) can be used for adjusting the settings of your LCD Monitor. Press the MENU key to open the OSD. You can use the OSD to adjust the picture quality, OSD position and general settings. For advanced settings, please refer to following page:

Main Page

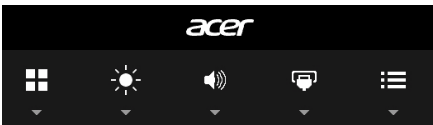

1. Mode
2. Brightness
3. Volume
4. Input selection
5. Function menu

Turn Mode on or off

Open the Mode control and turn Mode on or off using the adjustment arrows (OFF/ON), and select which profile to use (Please see the OSD section for more information).

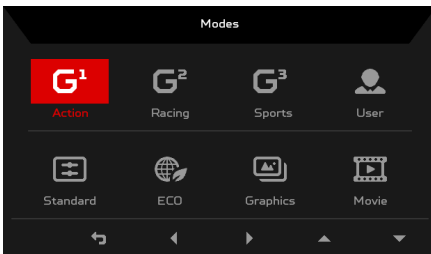

Adjusting the Brightness setting

Open the Brightness control and select the brightness setting using the arrows. When you are done, use  to go back one level.



Adjusting the Volume

Open the Volume control and set the volume using the arrows. When you are done, use ↶ to go back one level.

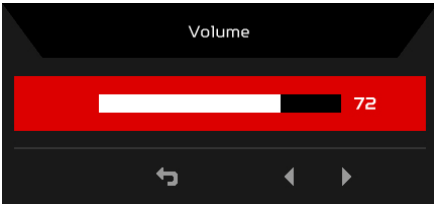

Note: Adjustment of the volume control as well as the equalizer to other settings than the center position may increase the ear/headphone output voltage and therefore the sound pressure level.

Selecting the Input

Open the input control and select HDMI, DisplayPort, DVI, or VGA. When you are done, use ↶ to go back one level.

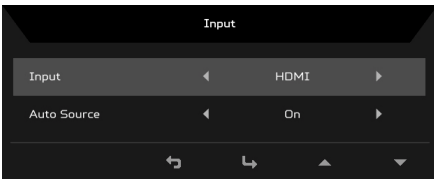



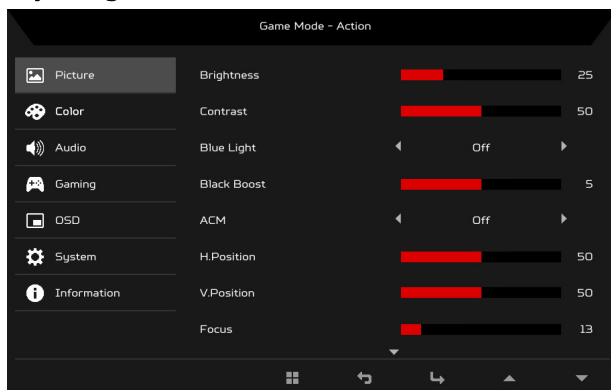

The Function page

Open the Function page to select Picture, Color, Audio, Gaming, OSD or System functions, and adjust the settings which you want using the arrows. You can also view your monitor's system information from this page. When you are done, use  to go back one level.

Adjusting the Picture



1. Press the MENU key to bring up the OSD.
2. Using the / keys, select Picture from the OSD. Then navigate to the setting you wish to adjust.
3. Use the / keys to adjust the sliding scales.
4. The Picture menu can be used to adjust the Brightness, Contrast, Blue Light, Black Boost, ACM, H. Position, V. Position, Focus, and Clock.
5. Brightness: Adjust the brightness from 0 to 100.



Note: Adjusts the balance between light and dark shades.

6. Contrast: adjust the contrast from 0 to 100.



Note: Sets the degree of difference between light and dark areas.

7. Blue Light: filter out blue light by adjusting different Blue Light showing ratio - 80%, 70%, 60%, 50%.



Note: Higher values allow more blue light through. For the best protection, select a lower value.

8. **Black Boost:** This boosts the amplitude of the dark color levels of the display– blacks will be less black. The higher the level, the higher the boost.
9. **ACM:** Turn ACM on or off. The default is off.
10. **H. Position:** Adjust the horizontal position from 0 to 100.
11. **V. Position:** Adjust the vertical position from 0 to 100.
12. **Focus:** Adjust the focus from 0 to 100.
13. **Clock:** Adjust the clock from 0 to 100.

Adjusting the Color

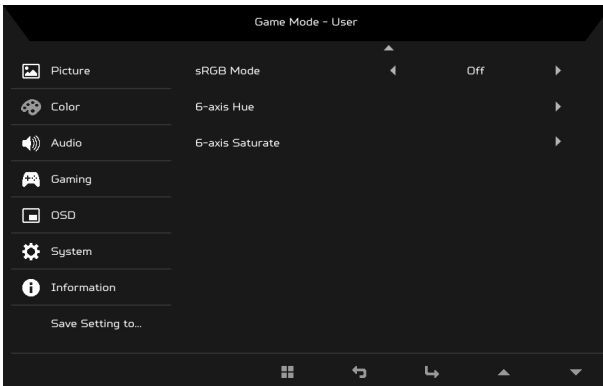
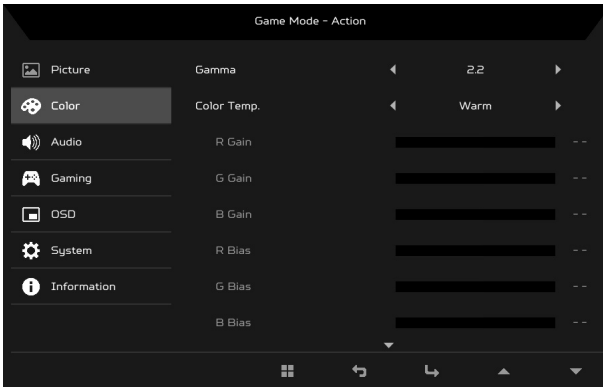

1. Press the MENU key to open the OSD.
2. Using the ▲/▼ keys, select Color from the OSD. Then navigate to the setting you wish to adjust.
3. Use the ◀/▶ keys to select setting.

4. Gamma mode allows you to adjust the luminance tone. The default value is 2.2 (standard value for Windows).
5. Color temperature: Default is warm. You can choose Cool, Warm, Bluelight or User.
6. sRGB mode is for getting better color matching representation with the peripheral device, such as DSCs or printers.
7. 6-axis Hue: Adjust the red, green, blue, yellow, magenta and cyan hue.
8. 6-axis Saturate: Adjust the red, green, blue, yellow, magenta and cyan saturation.

Adjusting the Audio

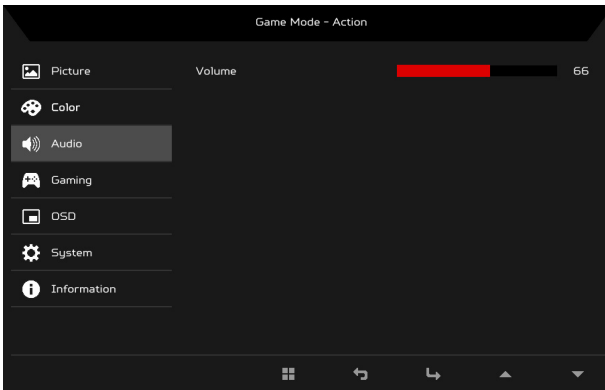

1. Press the MENU key to open the OSD.
2. Using the ▲/▼ keys, select Audio from the OSD. Then navigate to the setting you wish to adjust.
3. Use the ◀/▶ keys to select setting.
4. Volume: Adjusts the volume.

Adjusting the Gaming

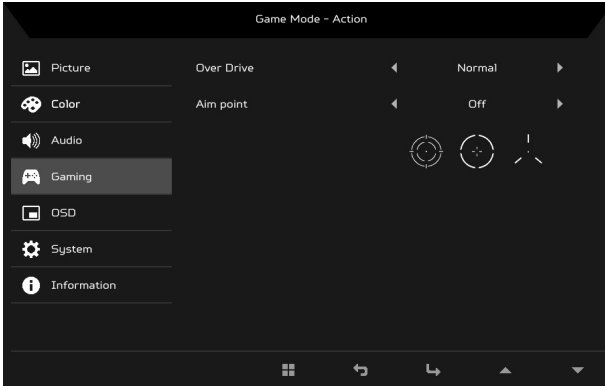

1. Press the MENU key to open the OSD.
2. Using the ▲/▼ keys, select Gaming from the OSD. Then navigate to the setting you wish to adjust.
3. Use the ◀/▶ keys to select setting.
4. Over Drive: Select Off, Normal, or Extreme.
5. Aim point: Show an Aim point on the screen for shooting games.

Adjusting the OSD

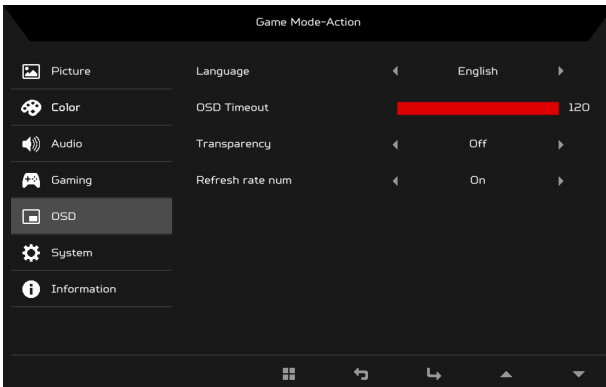

1. Press the MENU key to open the OSD.
2. Using the ▲/▼ keys, select OSD from the OSD. Then navigate to the setting you wish to adjust.
3. Use the ◀/▶ keys to adjust any sliding scales.
4. Language: Set the OSD menu language.

5. **OSD Timeout:** Adjust the delay before turning the off the OSD menu.
6. **Transparency:** Select the transparency when using gaming mode. The transparency can be 0% (OFF), 20%, 40%, 60%, or 80%.
7. **Refresh rate num:** Display the panel's current refresh rate on the screen.

Adjusting the System

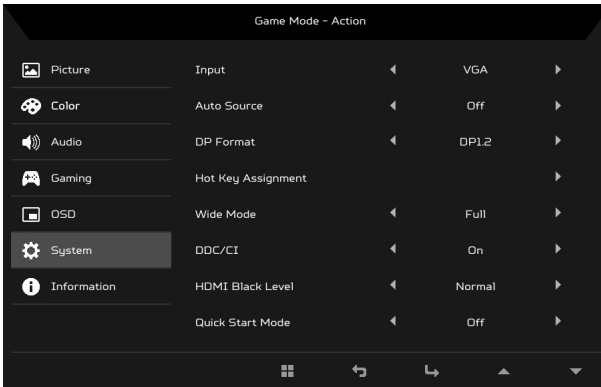

1. The System menu can be used to select settings such as Input, Wide Mode, and others.
2. Press the MENU key to open the OSD.
3. Using the ▲/▼ keys, select System from the OSD. Then navigate to the setting you wish to adjust.
4. Use the ◀/▶ keys to select the setting.
5. **Input:** Select the source from HDMI, DP In, DVI, or VGA.
6. **Auto Source:** Automatically searches for available input sources.
7. **DP Format:** You can select which DP format you are using. The default is set at DP1.2.
8. **Hot Key Assignment:** Select the function of Hot Key 1 or Hot Key 2.
9. **Wide Mode:** You can select which screen aspect you are using. The options are Full and Aspect.
10. **DDC/CI:** Allows the monitor settings to be set through the software on the PC.



Note: DDC/CI, short for Display Data Channel/Command Interface, which allows monitor controls to be sent via software.

11. **HDMI Black Level:** You can select the level of blackness under HDMI source. The options are Normal and Low.
12. **Quick Start Mode:** Enable monitor rapidly.

Product information

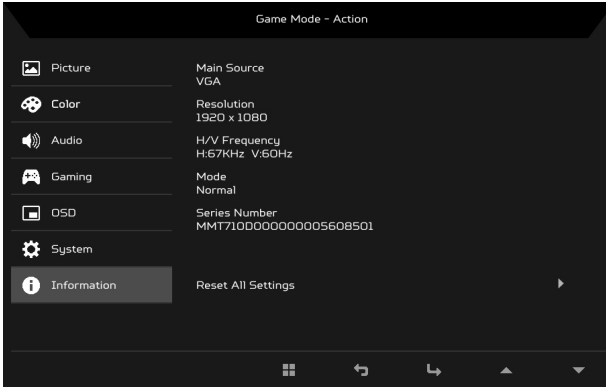

1. Press the MENU key to open the OSD.
2. Using the ▲/▼ keys, select Information to view the basic information for your monitor and current input.
3. **Reset All Settings:** Resets all settings to the factory defaults.

TROUBLESHOOTING

Before sending your LCD monitor for servicing, please check the troubleshooting list below to see if you can self-diagnose the problem.

(HDMI/DP/DVI Mode)

Problems	Current Status	Remedy
No Picture	LED ON	<ul style="list-style-type: none"> ● Using OSD, adjust brightness and contrast to maximum or reset to their default settings.
	LED OFF	<ul style="list-style-type: none"> ● Check the power switch.
		<ul style="list-style-type: none"> ● Check if AC power cord is properly connected to the monitor.
LED displays amber color		<ul style="list-style-type: none"> ● Check if video signal cable is properly connected at the back of monitor.
		<ul style="list-style-type: none"> ● Check if the power of computer system is ON.
Abnormal Sound (Only Audio-Input model) (Optional)	No sound, or sound level is too low	<ul style="list-style-type: none"> ● Check the audio cable with the host PC is connected.
		<ul style="list-style-type: none"> ● Check if the volume setup of the host PC is in minimum position and try to raise the volume level.

(VGA Mode)

Problems	Current Status	Remedy
No Picture	LED ON	<ul style="list-style-type: none">● Using OSD, adjust brightness and contrast to maximum or reset to their default settings.
	LED OFF	<ul style="list-style-type: none">● Check the power switch.● Check if AC power cord is properly connected to the monitor.
		LED displays amber color
Abnormal Picture	Unstable Picture	<ul style="list-style-type: none">● Check if the specification of graphics adapter and monitor is in compliance which may be causing the input signal frequency mismatch.
	Display is missing, center shift, or too small or too large in display size	<ul style="list-style-type: none">● Using OSD, adjust RESOLUTION, CLOCK, CLOCK-PHASE, H-POSITION and V-POSITION with non-standard signals.● Using OSD, in case of missing full-screen image, please select other resolution or other vertical refresh timing.
		<ul style="list-style-type: none">● Wait for a few seconds after adjusting the size of the image before changing or disconnecting the signal cable or powering OFF the monitor.
Abnormal Sound (Only Audio-Input model) (Optional)	No sound, or sound level is too low	<ul style="list-style-type: none">● Check the audio cable with the host PC is connected.
		<ul style="list-style-type: none">● Check if the volume setup of the host PC is in minimum position and try to raise the volume level.



Acer Incorporated
8F, 88, Sec. 1, Xintai 5th Rd., Xizhi
New Taipei City 221, Taiwan

Declaration of Conformity

We,

Acer Incorporated

8F, 88, Sec. 1, Xintai 5th Rd., Xizhi, New Taipei City 221, Taiwan

And,

Acer Italy s.r.l.

Via Lepetit, 40, 20020 Lainate (MI) Italy

Tel: +39-02-939-921, Fax: +39-02 9399-2913

www.acer.it

Product:	LCD Monitor
Trade Name:	ACER
Model Number:	KG251Q
SKU Number:	KG251Q XXXXX
	("x" = 0~9, a~z, A~Z, or blank)

We, Acer Incorporated, hereby declare under our sole responsibility that the product described above is in conformity with the relevant Union harmonization legislations as below Directive and following harmonized standards and/or other relevant standards have been applied:

EMC Directive: 2014/30/EU

EN55032:2012/AC:2013 Class B

EN 55024:2010

EN61000-3-2:2014 Class D

EN61000-3-3:2013

LVD Directive: 2014/35/EU

EN 60950-1:2006/A11:2009/A1:2010/A12:2011/A2:2013

RoHS Directive: 2011/65/EU

EN 50581:2012

ErP Directive: 2009/125/EC

Regulation (EC) No. 1275/ 2008; EN 50564:2011

Year to begin affixing CE marking: 2017.

RU Jan / Sr. Manager
Acer Incorporated (Taipei, Taiwan)

Mar. 05, 2017

Date



Acer America Corporation
333 West San Carlos St.,
Suite 1500
San Jose, CA 95110
U. S. A.
Tel : 254-298-4000
Fax : 254-298-4147
www.acer.com



Federal Communications Commission Declaration of Conformity

This device complies with Part 15 of the FCC Rules. Operation is subject to the following two conditions:
(1) this device may not cause harmful interference, and (2) this device must accept any interference received, including interference that may cause undesired operation.

The following local Manufacturer /Importer is responsible for this declaration:

Product:	LCD Monitor
Model Number:	KG251Q
SKU Number:	KG251Q xxxxxx ("x" = 0~9, a ~ z, or A ~ Z)
Name of Responsible Party:	Acer America Corporation
Address of Responsible Party:	333 West San Carlos St. Suite 1500 San Jose, CA 95110 U. S. A.
Contact Person:	Acer Representative
Phone No.:	254-298-4000
Fax No.:	254-298-4147